

WT908-4T FAN COIL THERMOSTAT

Application: Heat/cool, 3speed fan, 4-pipe fan coil unit, Remote sensor

Installation and operation instructions

SPECIFICATION:

Electrical Rating.....	100-240VAC 50/60Hz
Fan Relay Amps inductive.....	5(3)A
Heat/Cool Relay Amps inductive.....	1(0.5)A
Set point Temperature Range.....	5°C to 35°C
Dimensions.....	115mm × 90mm × 28mm
Color.....	White

FEATURE:

- Large LCD display with backlight
- Set points and room temperature display simultaneously
- Maintains the temperature within the range of 0.5°C to the set point
- Automatic fan with adjustable 3-speed fan.
- Manual change over
- Inner sensor and remote sensor can automatic exchange as your requires
- Never lose user setting in the event of power-off, no battery is required
- Display temperature recalibrates
- Sleep mode option.

OPERATION

The Thermostat Buttons and Switches

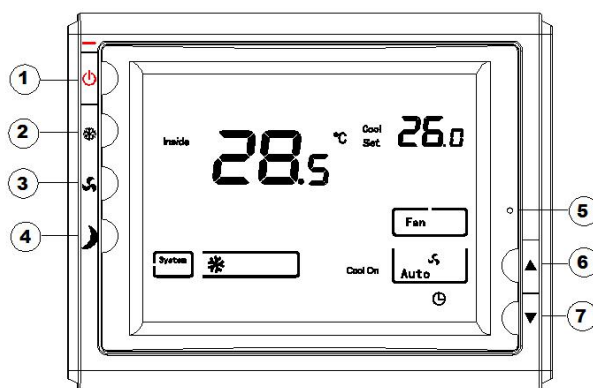

- (1) Power button
- (2) System switch (**HEAT, COOL**)
- (3) Fan switch (**AUTO, LOW, MED, HIGH**)
- (4) Sleep operation button
- (5) Reset switch
- (6) ▲ Raises Temperature setting
- (7) ▼ Lower Temperature setting

The Display

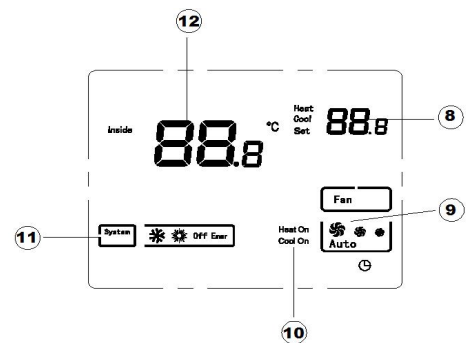

- (8) Setting temperature
- (9) Indicate fan switch position
- (10) **Heat on** shows when the thermostat is calling for heat.
Cool on shows when the thermostat is calling for cool.
- (11) Shows system mode
- (12) Room temperature

INSTA

ALL THE THERMOSTAT

ATTACH THERMOSTAT BASE TO WALL

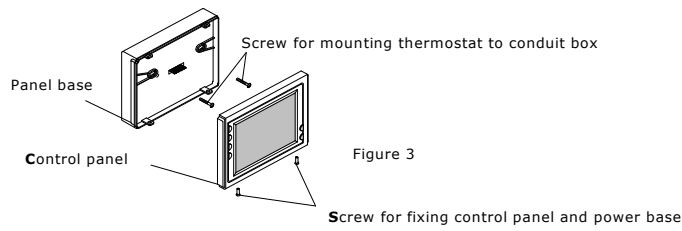

- 1.. Remove 2 screws from the bottom of thermostat. Gently pull the control panel straight off the base. Forcing or prying on the thermostat will cause damage to the unit.
2. Connect wires beneath terminal screws on power supply module using appropriate wiring schematic. See figure 4
3. Using two mounting screws mount the power base to the wall. Place a level against bottom of base, adjust until level, and then tighten screws. (Leveling is for appearance only and will not affect thermostat operation.)
4. Replace control panel on the power base and fix power base and control panel by removed two screws in item 1

WIRING DIAGRAM

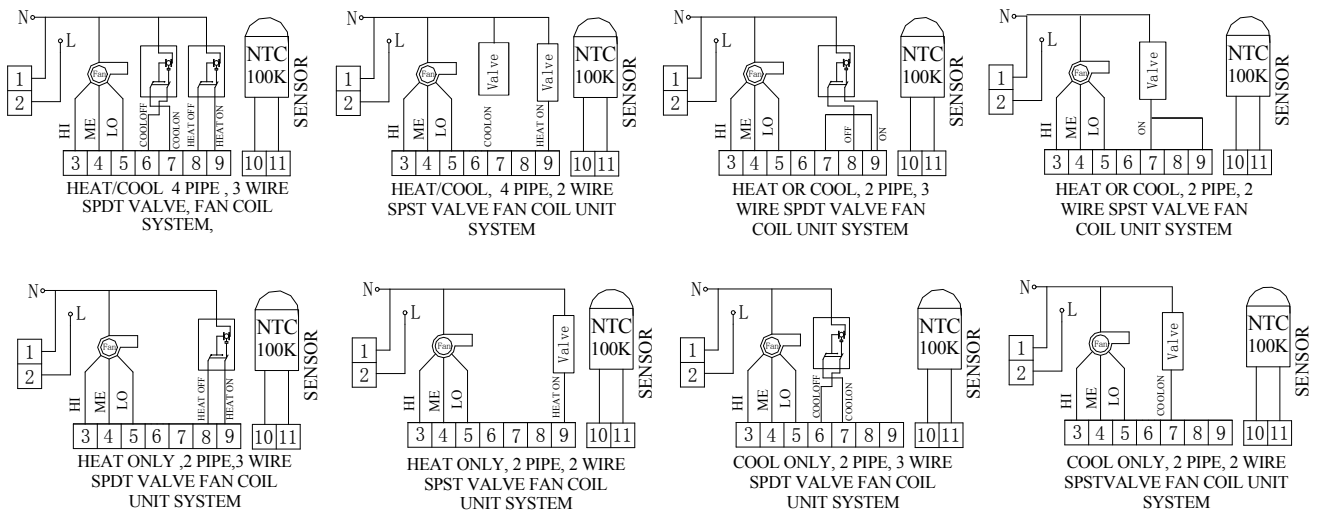
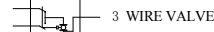
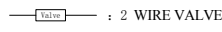

Figure 4

NOTE



POWER: 100-240VAC 50/60HZ

Please note:

Terminals 10 & 11 connected with remote sensor for measuring room temperature. Inner sensor & remote sensor can automatic exchange . When you connected with remote sensor, the inner sensor will lose function. It means you can only select one sensor for measuring room temperature.

CHECK THERMOSTAT OPERATION

Switch on the thermostat

Fan operation

1. Push fan button, display will show and Auto separately means fan rotate in HI MED LOW or AUTO speed.
2. If you select AUTO speed, fan operation will change speed according to the difference between the room temperature and set temperature. If room temperature is 3°C higher than setting temperature in cooling or 3°C lower than setting temperature in Heating. Fan will run in HI speed. If room temperature is 2°C- 3°C higher than setting temperature in cooling or 2°C-3°C lower than setting temperature in Heating. Fan will run in Medium speed. If room temperature is 0°C-2°C higher than setting temperature in cooling or 0°C-2°C lower than setting temperature in Heating. Fan will run in Low

speed.

Heat system operation

1. Press system switch to heat mode ()
2. Press “▲” to adjust the thermostat setting above the room temperature. The heating system should start to operate.
3. Press “▼” to adjust the thermostat setting below the room temperature. The heating system should stop operating.

Cooling system operation

1. Press system switch to cool mode ()
2. Press “▼” to adjust thermostat setting below room temperature. The cooling system should start to operate.
3. Press “▲” to adjust temperature setting above room temperature. The cooling system should stop operating

Sleep operation

Push sleep operation button , appears indicate during the following 8 hours, the thermostat will

control heating or cooling according to following curve. Push sleep operation button again, disappears indicate the sleep operation feature is canceled.

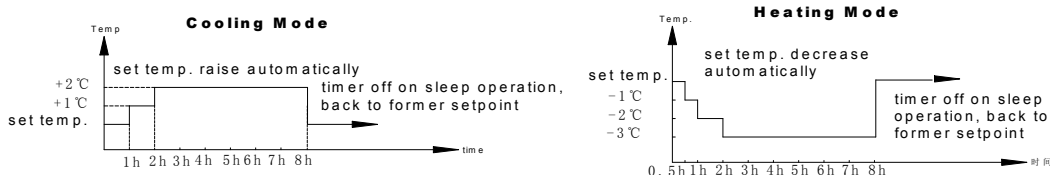

Applications

System switch on cool mode: To achieve better sleep, 1 hour after sleeping mode setting, set point temperature will raise 1°C automatically, and 2 hours later, setting point temperature will raise 2°C and keep on with this temperature until timer off, which is 8 hours. After timer off, set point will be restored to formal setting automatically.

System switch on heat mode: To achieve better sleep, 0.5 hour after sleeping mode setting, set point temperature will decrease 1°C automatically, and 1 hour later, setting point temperature will decrease 2°C, 2 hours later, setting will decrease 3°C and keep on with this temperature until timer off, which is 8 hours.

After timer off, set point will be restored to formal setting automatically.

CONFIGURATION

The configuration menu allows you to set certain thermostat operating characteristics to your system or personal requirements. Switch off the thermostat and hold the sleep operation Button ④ for over 3 second till power on again means you have entered the first configuration menu item. There are 6 menu items. Press button ④ to change to the next item. To exit the menu and return to the normal operation, switch off the thermostat and switch it on again. If no keys are pressed within 20 seconds the thermostat will be switched off.

Return to factory default : Switch off the thermostat, Press button ④ over 4 seconds till power on again means you have entered the menu, long press button ④ over 4 seconds after "dEF" blinking readout three times, it means return to factory default. **(MARK: Please don't operate before malfunction.)**

Step	Press buttons	Displayed (factory default)	Press▲、▼to select	Descriptions
1	④ 3 seconds	01 (0)	-3 --- +3	Adjust temperature coefficient
2	④	02 (35℃)	20℃—35℃	Select maximum setting temperature for heating
3	④	03 (5℃)	5℃—20℃	Select minimum setting temperature for cooling
4	④	04 (rE)	rd, rE	Memorize option before power loss
5	④	05 (1)	1、2、3	Display backlight option
6	④	06 (0n)	OFF/0n	Fan stop option

1) Select temperature recalibrates Adjustment 3 LO to 3 HI -

You can adjust the room temperature display up to 3 higher or lower. Your thermostat was accurately calibrated at the factory but you have the option to change the display temperature to match your previous thermostat.

2) Select maximum temperature for heating.

This feature provides a maximum setpoint temperature for heat. The default setting is 35℃, It can be changed between 20℃to 35℃

3) Select minimum temperature for cooling

This feature provides a minimum setpoint temperature for cooling. The default setting is 5℃, It can be changed between 5℃ to 20℃

4) Memorize option before power loss

Using ▲ & ▼ button to select between "rE" and "rd". "rE" means the thermostat will Memorize its ON or OFF status before power loss. After power supply comes to normal again, the thermostat will remain ON or OFF according to what it is before power loss. "rd" means no matter the thermostat is switched on or off before power loss, after the power supply comes to normal again the thermostat will keep power off

5) Display backlight option

Select 1 the light will be on when any button of the thermostat is touched. Select 2 the display will keep the light on continuously. Select 3 the display will keep the light off continuously Factory default is 1

6) Fan stop option

Using ▲ & ▼ button to select between "On" and "OFF". If you select "On", the thermostat will turn on the fan at a speed provided by the Fan Switch and will not stop the fan when there is no call for heat or cool. If you select "OFF", the thermostat will stop the fan when there is no call for heat or cool.

Mark: RESET function.

This function can help operator to recovery system when fault happened , display outoforder or system halted. Please use a pin to insert in button ⑤ hole till sounded click, then loosen it. Switch on thermostat and observe it, if there still have troubles, please don't hesitate to contact with local agency for warranty.